



INSTRUCTION MANUAL

VHF AIR BAND TRANSCEIVER
IC-A210E



Icom Inc.

IMPORTANT

READ ALL INSTRUCTIONS carefully and completely before using the transceiver.

SAVE THIS INSTRUCTION MANUAL — This instruction manual contains important operating instructions for the IC-A210E.

EXPLICIT DEFINITIONS

The explicit definitions below apply to this instruction manual.

WORD	DEFINITION
△WARNING!	Personal injury, fire hazard or electric shock may occur.
CAUTION	Equipment damage may occur.
NOTE	If disregarded, inconvenience only. No risk of personal injury, fire or electric shock.

Icom, Icom Inc. and the Icom logo are registered trademarks of Icom Incorporated (Japan) in Japan, the United States, the United Kingdom, Germany, France, Spain, Russia, Australia, New Zealand, and/or other countries. IBM is a registered trademark of International Business Machines.

FEATURES

○ Large, bright OLED display

A fixed mount VHF airband first, the IC-A210E has an organic light emitting diode (OLED) display. The all man-made lighting emits its own light, and the display offers many advantages in brightness, vividness, high contrast, wide viewing angle and response time compared to a conventional display. In addition, the auto dimmer function can adjust the display for optimum brightness, during the day or night.

○ Easy channel selection

It's fast and easy to select any of the memory channels in the IC-A210E. The "flip-flop" arrow button switches between active and standby channels. The DualWatch function allows you to monitor two channels simultaneously. In addition, the history memory channel stores the last 10 channels used and allows you to recall those channels easily.

○ GPS memory function

When connected to an external GPS receiver* equipped with an airport frequency database, the IC-A210E will instantly tune in the local airport frequency as you fly into its airspace.

*Ask your dealer for available GPS receiver details.

○ 13.8 V/27.5 V DC power source

The built-in DC-DC converter accepts a 13.8 or 27.5 V DC power source. The IC-A210E is easily installed in most airplanes or vehicles.

○ Intercom function

The IC-A210E has a built-in voice activated intercom function allowing the pilot to talk with a co-pilot, or other person, via headsets. The IC-A210E has adjustable audio level and squelch control functions.

PRECAUTIONS

⚠ WARNING! NEVER operate the transceiver with a headset or other audio accessories at high volume levels. Hearing experts advise against continuous high volume operation. If you experience a ringing in your ears, reduce the volume level or discontinue use.

⚠ WARNING! NEVER connect the transceiver to an AC outlet or to a power source of more than 28 V DC. Such a connection will damage the transceiver.

CAUTION: NEVER connect the transceiver to a power source that is DC fused at more than 10 A. Accidental reverse connection will be protected by this fuse, higher fuse values will not give any protection against such accidents and the transceiver will be damaged.

DO NOT operate the transceiver near unshielded electrical blasting caps or in an explosive atmosphere.

DO NOT connect the transceiver to a power source using reverse polarity. This connection will not only blow fuses but also may damage the transceiver.

DO NOT place unit in a non-secure place to avoid inadvertent use by children.

DO NOT push the PTT when not actually intending to transmit.

DO NOT use or place the transceiver in direct sunlight or in areas with temperatures below -20°C or above $+55^{\circ}\text{C}$.

DO NOT place the transceiver in excessively dusty environments.

DO NOT place the transceiver against walls. This will obstruct heat dissipation.

DO NOT use chemical agents such as benzine or alcohol when cleaning, as they damage the transceiver surfaces.

BE CAREFUL! The transceiver will become hot when operating continuously for long periods.

The antenna should also be spaced at least 1 m from any position occupied by any person on board of the aircraft.

Icom is not responsible for the destruction, damage to, or performance of any Icom or non-Icom equipment, if the malfunction is because of:

- Force majeure, including, but not limited to, fires, earthquakes, storms, floods, lightning, other natural disasters, disturbances, riots, war, or radioactive contamination.
- The use of Icom transceivers with any equipment that is not manufactured or approved by Icom.

TABLE OF CONTENTS

IMPORTANT.....	i	■ Programming channel names (Regular memory channel only)	15
EXPLICIT DEFINITIONS.....	i	■ Programming group names (Group memory channel only)	15
FEATURES.....	i	■ Programming channel tag (Group memory channel only).....	16
PRECAUTIONS.....	ii	■ Channel tag list.....	16
TABLE OF CONTENTS.....	iii	■ GPS memory.....	17
1 PANEL DESCRIPTION.....	1 – 4	■ GPS memory edit.....	17
■ Front panel	1	■ Memory protection	17
■ Rear panel.....	3	4 OTHER FUNCTIONS.....	18 – 19
■ Main unit.....	3	■ Lock function	18
■ Function display	4	■ Accessing 121.5 MHz emergency frequency	18
2 BASIC OPERATION.....	5 – 8	■ Intercom function.....	19
■ Frequency selection	5	■ Squelch test function.....	19
■ Standby frequency selection (Step 1-2)	5	■ Frequency step setting	19
■ Frequency exchanging (Step 2-2)	6	5 MENU MODE.....	20 – 25
■ Receiving.....	6	■ MENU mode programming.....	20
■ Transmitting.....	6	■ MENU mode items	21
■ Frequency setting example	7	6 CLONING.....	26
■ Direct frequency setting mode operation.....	8	7 OPTIONS	27
■ DualWatch operation.....	8	8 SPECIFICATIONS	28
3 MEMORY OPERATION	9 – 17	9 INFORMATION	29
■ Programming notes	9	■ Channel ID list.....	29
■ Entering memory mode.....	9	■ About CE and DOC	29
■ Memory channel type.....	9	■ Disposal.....	29
■ Channel selection.....	10	INDEX.....	30 – 32
■ Programming a memory channel.....	10		
■ Programming example	11		
■ Transferring memory contents.....	12		
■ Memory mode menu (Regular and group memory channels only)	12		
■ Regular memory channel	13		
■ Group memory channel.....	13		
■ History memory channel	14		
■ Clearing the memory contents (Regular and group memory channels only)	14		

■ Front panel

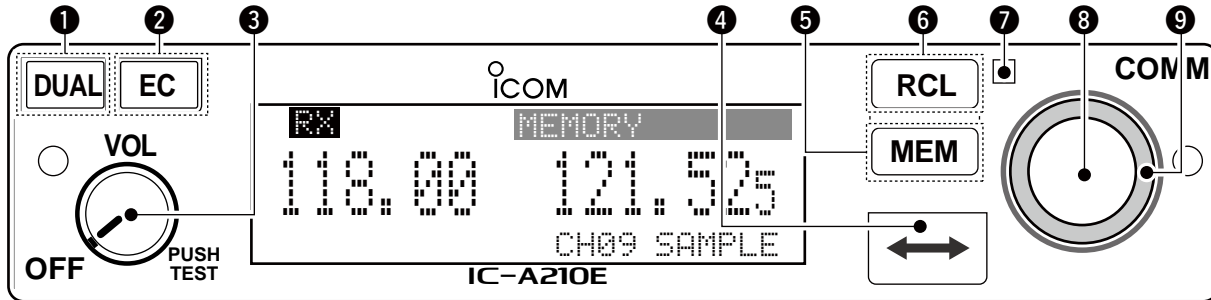

① DUAL SWITCH [DUAL]

- Push to turn DualWatch operation ON or OFF (p. 8).
- Hold down for 2 seconds to turn the intercom function ON or OFF.

② EMERGENCY CHANNEL SWITCH [EC]

- Push to set the emergency frequency (121.5 MHz) as the standby frequency (p. 18).
- Hold down for 2 seconds to enter the direct frequency setting mode (p. 8), and set the emergency frequency (121.5 MHz) (p. 18).

③ VOLUME/POWER SWITCH [VOL]

- Turn [VOL] to switch the power ON or OFF (p. 5).
- Adjusts the audio output level.
The volume level bar appears while rotating [VOL].
- Push to set the squelch test function ON or OFF (p. 19).

④ FREQUENCY EXCHANGE (FLIP-FLOP) SWITCH[↔]

- Push to exchange the standby frequency with the active frequency (p. 6).
- Hold down for 2 seconds to enter direct frequency setting mode (p. 8).

1 PANEL DESCRIPTION

■ Front panel (Continued)

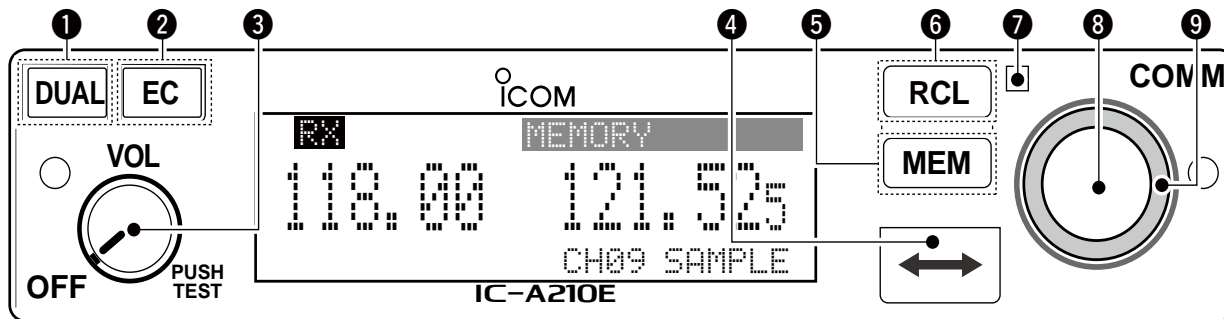

5 MEMORY SWITCH [MEM]

Hold down for 2 seconds to program a displayed frequency to any blank regular memory channel or delete/revive the selected memory channel (depending on the operating mode) (p. 9).

6 RECALL SWITCH [RCL]

- Push to enter/exit the memory mode (p. 9).
- Hold down for 2 seconds to enter/exit the menu mode (p. 20).

7 LIGHT-SENSITIVE DETECTOR

This detector senses ambient light. The detector is used to adjust “Dimmer brightness (Low/High)” (p. 23) automatically when the “Dimmer Mode” (p. 23) is set to ‘AUTO.’

8 INNER (Small) TUNING DIAL [DIAL]

- Rotate to set the standby frequencies (kHz digit) (p. 5), memory channels (p. 10), MENU mode settings (p. 20).
- Hold down for 2 seconds to turn the dial/panel lock function ON (p. 18).

9 OUTER (Large) TUNING DIAL [O-DIAL]

Rotate to set the standby frequency (MHz digit) (p. 5), group memory channel (p. 13), cursor position (p. 15).

■ Rear panel

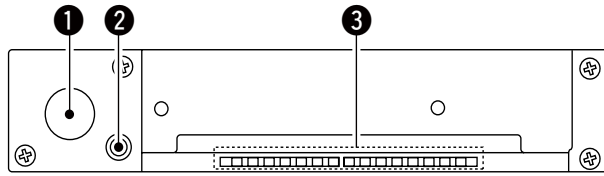

For regular type

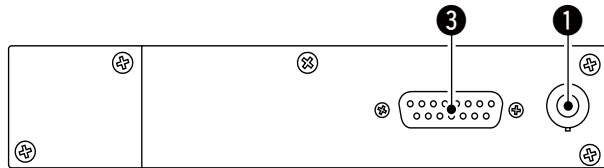

For the third party* compatible type (MB-113)

NOTE: Supplied with some transceiver's versions.

*Ask your dealer for available products details.

① ANTENNA CONNECTOR

Connect an antenna connector.

② DATA JACK

Connect an optional cloning cable (OPC-1529R) (p. 27).

③ DC, MICROPHONE, SPEAKER, HEADPHONE AND DATA JACK

Connect a 13.8 V or 27.5 V DC power supply, speaker, headphone and third party GPS receiver*1.

Refer to the "INSTALLATION GUIDE" for details.

*1 Ask your dealer for available GPS receiver details.

■ Main unit

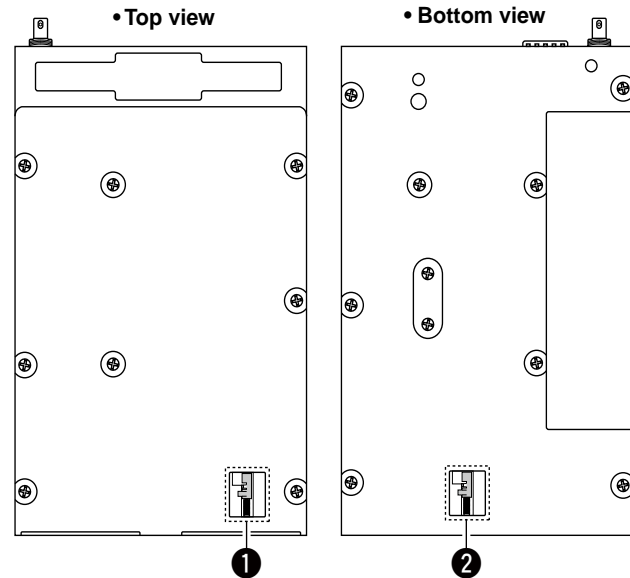

① Metal catch (For Icom products)

Use to attach to an installation rack for Icom products.

② Metal catch (For third party products*)

Use to attach to an installation rack for third party products*.

*Ask your dealer for available products details.

1 PANEL DESCRIPTION

■ Function display

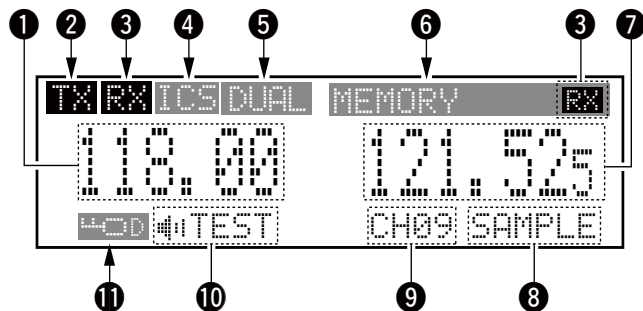

1 ACTIVE FREQUENCY INDICATOR

- Shows the active frequency (p. 6).
- Shows the MENU mode items in the MENU mode (p. 20).

2 TX INDICATOR

Appears while transmitting (p. 6).

3 RX INDICATOR

- Appears when receiving a signal on the active frequency signal (p. 6).
- Appears when receiving a signal on the standby frequency signal during DualWatch operation (p. 8).
- Appears when opening the active frequency's squelch function (p. 6).

4 INTERCOM INDICATOR

Appears when the intercom function is in use (p. 19).

5 DUALWATCH INDICATOR

Appears when the DualWatch function is active (p. 8).

6 MEMORY CONDITION INDICATOR

- Indicates "MEMORY" when the regular memory channel is selected (p. 13).
- Indicates "GRP01-GRP20" when the group memory channel is selected (p. 13). The group name is also indicated if the name has been entered.
- Indicates "HISTORY" when the history memory channel is selected (p. 14).
- Indicates "GPS" when the GPS memory channel is selected (The third party GPS receiver is required) (p. 17).

7 STANDBY FREQUENCY INDICATOR

- Shows the standby frequency (p. 5).
- Shows the setting values in the MENU mode (p. 20).

8 CHANNEL NAME INDICATOR

Shows the channel name during memory mode (p. 15).

9 MEMORY CHANNEL INDICATOR

Shows the selected memory channel number during memory mode (p. 13).

10 TEST INDICATOR

Appears while the squelch test function is active (p. 19).

11 LOCK INDICATOR (p. 18)

- Indicates "LOD" while the dial lock function is in use.
- Indicates "LOP" while the panel lock function in use.

■ Frequency selection

IC-A210E has two ways to select the desired frequency.

◇ General frequency selection

Select the desired frequency which is used for the next operating frequency in the standby frequency indicator. Then exchange the active frequency for the standby frequency.

NOTE: Operate from “Standby frequency selection (Step 1-2)” to “Frequency exchanging (Step 2-2)” as pages 5, 6.

◇ Direct frequency selection

The desired frequency direct selection is available.
Refer to “Direct frequency selection mode operation.”

TIP: For quick frequency setting, often used frequencies can be programmed into memory channels. Refer to “MEMORY OPERATION” (pp. 9–17).

When a memory channel is recalled, the previous standby frequency is erased.

■ Standby frequency selection (Step 1-2)

CAUTION: DO NOT turn the power ON until the aircraft engines have been started. It is very important for protection of the power supply circuit.

- ① Rotate **[VOL]** clockwise to turn power ON.
 - Previously used frequencies appear in the active and standby frequency indicators.
- ② Rotate **[DIAL]** and **[O-DIAL]** to select the desired frequency to the standby frequency.
 - The active frequency is not affected.
 - Rotate **[O-DIAL]** to set above 1 MHz digit.
 - Rotate **[DIAL]** to set below 100 kHz digit.
 - Set the frequency step* in the menu mode (p. 25).
*Varies depending on the transceiver version.

2 BASIC OPERATION

■ Frequency exchanging (Step 2-2)

- ① After selecting the standby frequency, push [↔] to exchange it with the active frequency.

NOTE: DO NOT hold down [↔] continuously. Otherwise, the standby frequency disappears. If this happens, again hold down [↔] until the standby frequency reappears.

- Adjust the squelch level in the menu mode, if necessary (p. 22).
 - Rotate [VOL] to set the volume level, if necessary.
 - When receiving a signal, "RX" appears and audio is heard from the speaker or headset.
 - Further adjustment of audio level may be necessary at this point.
- ② Hold down [PTT] to transmit, then speak into the microphone.
 - Transmit indicator "TX" lights.
 - ③ Release [PTT] to receive.

Frequency exchanging can be also performed remotely from the yoke-mounted frequency exchange switch.

■ Receiving

- ① Select an operating frequency.
 - Refer to pages 5, 6 for details.
 - "RX" appears when receiving a signal or opening squelch.
- ② Push [VOL] to open the squelch manually.
 - Refer to page 19 "Squelch test function" for details.
- ③ Rotate the volume control to adjust the audio level.







■ Transmitting

NOTE: To prevent interference, listen on the frequency before transmitting. If the frequency is busy, wait until the frequency is clear.

- ① Select the yoke-mounted communication/intercom switch to the "communication" position.
- ② Select an operating frequency.
 - Refer to pages 5, 6 in details.
- ③ Push the PTT switch.
 - "TX" appears.
- ④ Speak into the microphone at your normal voice level.
 - **DO NOT** set the microphone too closely to your mouth or speak too loudly. This may distort the signal.
- ⑤ Release the PTT switch to receive.

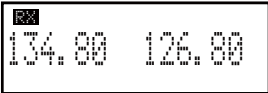
Frequency setting example

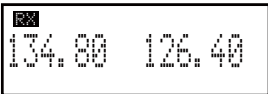
The following example shows to how to set 126.40 MHz as the standby frequency and then exchange it with the active frequency indicator.

STEP	DISPLAY	NOTE
		Previously used frequencies appear.
<p>① Rotate [O-DIAL] clockwise to select "126" MHz.</p>	 	Rotate the large tuning dial to change the standby frequency in MHz steps.
<p>② Rotate [DIAL] counterclockwise to select "400" kHz.</p>	 	Rotate the small tuning dial to change the standby frequency in kHz steps.
<p>③ Push [↔]. NOTE: DO NOT hold down [↔] continuously. Otherwise the standby frequency disappears. If this happens, hold down [↔] until the standby frequency reappears.</p>		The active frequency and the standby frequencies are exchanged.

2 BASIC OPERATION

■ Direct frequency setting mode operation

The direct frequency setting mode operation is useful when setting a desired frequency directly as the active frequency.

- ① Hold down [**↔**] for 2 seconds to enter the direct frequency setting mode.
 - Only the active frequency is displayed.
- ② Set an operating frequency.
 - Refer to pages 5, 6 in details.

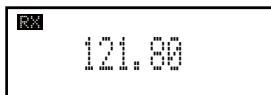

- ③ Push [**RCL**] or [**↔**] to exit the direct frequency setting mode.

■ DualWatch operation

The DualWatch operation monitors the active frequency at certain intervals, even when receiving a signal on the standby frequency. When a signal is received on the active frequency, the radio switches to the active frequency and stays on it until the signal disappears, irrespective of the standby frequency status.

- ① Push [**DUAL**] to enter DualWatch operation.
 - "DUAL" appears on the active frequency indicator.
 - The active or standby frequency's "RX" blinks when receiving a signal or opening the squelch.

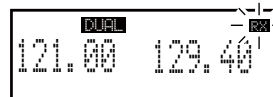

- ② Push [**DUAL**] again to exit DualWatch operation.
 - "DUAL" disappears.

ATTENTION! During DualWatch operation, the standby frequency's audio may be interrupted at the monitoring interval, but this is not a malfunction.

■ Programming notes

◇ Blank channel

A memory or group channel with no frequency content is called as a blank channel. When a blank channel is selected while memory programming, “———” appears instead of a frequency.

◇ Memory protect function

IC-A210E has a memory protect function. The function prevents accidental changes or deletion.

The function can be set in the MENU mode (p. 22).

■ Entering memory mode

- Push **[RCL]** to enter the memory mode.
- Push **[RCL]** to set the selected memory channel frequency to the standby frequency, then exit the memory mode.
- Hold down **[RCL]** for 2 seconds to exit the memory mode without changing the previously set standby frequency.

■ Memory channel type

There are four memory types. The memory types are as follows:

◇ Regular memory channel (MEMORY)

There are up to 10 available memory channels.

◇ Group memory channel (GRP01–GRP20)

There are up to 200 group channels, with 10 channels in each of 20 groups.

◇ History memory channel (HISTORY)

There are up to 10 available history memory channels.

The active frequency is written into history memory channels automatically when pushing **[↔]** to exchange the active and standby frequency.

◇ GPS memory channel (GPS)

There are up to 10 available GPS memory channels.

When connected to an external GPS receiver* equipped with an airport frequency database, the frequency data such as nearby airports can be transferred into GPS memory channels.

*Ask your dealer for available GPS receiver details.

3 MEMORY OPERATION

■ Channel selection

The transceiver has 10 channels in the regular memory and 200 channels in the group memory. There are 10 channels in each of 20 groups (GRP01–GRP20).

- ① Push **[RCL]** to enter the memory mode.
 - The channel number appears.
 - The memory channel name also appears if it has been entered.
- ② Rotate **[O-DIAL]** to select the memory channel type.
 - Select from regular memory channel or group memory channel.
- ③ Rotate **[DIAL]** to select the desired memory channel number.



Transferring the memory channel to the active frequency is necessary if you want to operate on the memory channel frequency.

Refer to “Transferring memory contents” (p. 12) for details.

- ④ Push **[RCL]** to change to standby frequency to the selected memory channel frequency and exit the memory mode.

NOTE: Hold down **[RCL]** for 2 seconds to exit the memory mode without changing the previously set standby frequency.

■ Programming a memory channel

To program the memory channels, follow the steps below.

- ① Rotate **[DIAL]** and **[O-DIAL]** to set the desired frequency for the standby frequency.
- ② Push **[RCL]** to enter the memory mode.
 - The channel number appears.
 - The memory channel name also appears if it has been entered.
- ③ Rotate **[O-DIAL]** to select the desired memory channel type.
 - Select regular channel or group memory channel.
- ④ Push **[MEM]**, and then rotate **[O-DIAL]** to select the “REPLACE” menu.
 - The channel number blinks.
- ⑤ Rotate **[DIAL]** to select a channel to be programmed.
- ⑥ Push **[MEM]**, to program the frequency into the channel.
 - “WRITE COMPLETED” appears on the display when the regular memory channel is programmed.
- ⑦ Push **[RCL]** to exit the memory mode.

■ Programming example

The following is an example showing how to program 126.000 MHz into regular memory channel 4.

- ① Set a “126.000 MHz” in the standby display.

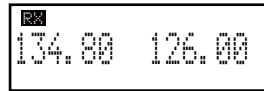

“126.00” appears in the standby display.

- ② Push **[RCL]**, then rotate **[O-DIAL]** to select “MEMORY”.



“MEMORY” and the channel number appear.

- ③ Select regular memory channel 4 with **[DIAL]**.



“.....” appears when no frequency has been programmed into the regular memory channel 4.

- ④ Push **[MEM]**, then rotate **[O-DIAL]** to select “REPLACE”.

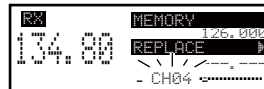

Regular memory channel number blinks.

- ⑤ Push **[MEM]** to store the desired frequency into the selected regular memory channel.



“WRITE COMPLETED” is displayed when the selected frequency is stored.

TIP: Hold down **[MEM]** for 2 seconds to program a displayed frequency into any blank memory channel automatically, after step ①.

NOTE: The programming is cancelled if all regular memory channels have already programmed.

3 MEMORY OPERATION

■ Transferring memory contents

This function transfers a memory channel's contents into the active frequency display and places the previous active frequency into the standby display.

- ① Push **[RCL]** to enter the memory mode.
 - The channel number appears.
 - The memory channel name also appears if it has been entered.
- ② Rotate **[O-DIAL]** to select the desired channel type.
 - Select regular, group history or GPS memory channel.
- ③ Rotate **[DIAL]** to select a memory channel to be transferred.
- ④ Push **[↔]** to transfer the memory channel frequency into the active frequency display.
 - The memory mode is then cancelled automatically.

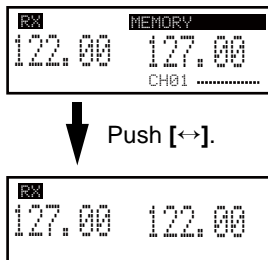

■ Memory mode menu (Regular and group memory channels only)

◇ REPLACE

Replacing the standby frequency with the memory channel frequency.

◇ DELETE

Deletes the selected memory channel.

◇ REVIVE

Returns the selected memory channel to its previous state.

◇ CH NAME (Regular memory channel only)

Sets the channel name to the selected regular memory channel.

◇ GRP NAME (Group memory channel only)

Sets the group name to the selected memory group.

◇ CH TAG (Group memory channel only)

Sets the channel tag to the selected memory channel (Selecting the group memory channel is the only option).

◇ DONE

Return to the memory mode.

■ Regular memory channel

The transceiver has 10 regular memory channels.

Five programming options are selectable.

The following functions are available:

REPLACE, DELETE, REVIVE and CHANNEL NAME EDIT functions.

- ① Push **[RCL]** to enter the memory mode.
 - The channel number appears.
 - The memory channel name also appears if it has been entered.



- ② Rotate **[O-DIAL]** to select the regular memory channel.
 - "MEMORY" appears.
- ③ Rotate **[DIAL]** to select the desired channel.
- ④ Push **[MEM]**, then rotate **[O-DIAL]** to select a menu option as follow.
 - The memory channel number blinks.

REPLACE	Replace to the standby frequency.
DELETE	Delete the memory channel.
REVIVE	Revive the previous memory channel data.
CH NAME	Edit the memory channel name.
DONE	Do nothing and return to the memory mode.

- ⑤ Push **[MEM]** to perform the selected action.

■ Group memory channel

The transceiver has 200 group memory channels comprised of 10 channels in each of 20 groups.

The following functions are available:

REPLACE, DELETE, REVIVE, GROUP NAME EDIT and CHANNEL TAG functions.

- ① Push **[RCL]** to enter the memory mode.
 - The channel number appears.
 - The memory channel name also appears if it has been entered.
- ② Rotate **[O-DIAL]** to select the group memory channel number.
 - A group number "GRP01-GRP20" appears.



- ③ Push **[DIAL]**, and then rotate **[O-DIAL]** to select the memory group from GRP01 to GRP20 if necessary.
 - The group and channel numbers blink.
- ④ Rotate **[DIAL]** to select the desired channel within the selected group.
 - Push **[DIAL]** again, or push **[RCL]** to set the memory group.
- ⑤ Push **[MEM]**, rotate **[O-DIAL]** to select a menu as follows.
 - The memory channel number blinks.

REPLACE	Replace to the standby frequency.
DELETE	Delete the memory channel.
REVIVE	Revive the previous memory channel data.
GRP NAME	Edit the group name.
CH TAG	Set the memory channel as a tag channel.
DONE	Do nothing and return to the memory mode.

- ⑥ Push **[MEM]** to perform the selected action.

3 MEMORY OPERATION

■ History memory channel

The transceiver has 10 history memory channels.

The standby frequency is stored into a history memory channel when pushing [↔].

The frequency is stored into the history memory channel in order from “CH01” to “CH10.”

- ① Push **[RCL]** to enter the memory mode.
 - The channel number appears.
 - The memory channel name also appears if it has been entered.
- ② Rotate **[O-DIAL]** to select the history memory channel.
 - “HISTORY” appears.



- ③ Rotate **[DIAL]** to select the desired channel.
 - Push [↔] to exchange the history memory channel frequency to the active frequency if necessary.
- ④ Push **[RCL]** to exit the memory mode.

■ Clearing the memory contents (Regular and group memory channels only)

Unwanted memory channels can be cleared.

- ① Push **[RCL]** to select memory mode.
 - The channel number appears.
 - The memory channel name also appears if it has been entered.
- ② Rotate **[O-DIAL]** to select the memory channel type.
 - Select from regular memory channel or group memory channel.
- ③ Rotate **[DIAL]** to select the desired channel.
- ④ Push **[MEM]**, then rotate **[O-DIAL]** to select “DELETE.”
 - The memory channel number blinks.



- ⑤ Push **[MEM]** to delete the memory channel data.
 - “- - - - -” appears momentarily, then the next selectable channel appears.



- ⑥ Push **[RCL]** to exit the memory mode.

NOTE: Instead of steps ④ and ⑤, holding down **[MEM]** for 2 seconds after step ③ also allows delete or revive operation.

■ Programming channel names (Regular memory channel only)

The regular memory channel can display a six character name in addition to the memory number.

- ① Push **[RCL]** to enter the memory mode, then rotate **[O-DIAL]** to select the regular memory channel in the memory mode.
- ② Rotate **[DIAL]** to select a desired channel.
- ③ Push **[MEM]**, then rotate **[O-DIAL]** to select “CH NAME.”
- ④ Push **[MEM]**. The channel name’s 1st digit blinks.
- ⑤ Rotate **[DIAL]** to select a desired character.
 - The character type as shown below is selectable.
 - Push **[DIAL]** to switch from capital letters (A, B, C, ...) → lower case (a, b, c, ...) → number (0, 1, 2, ...) → then again to capital letters (A, B, C, ...) in sequential order.
- ⑥ Rotate **[O-DIAL]** to select the next input digit.
- ⑦ Repeat ⑤–⑥ to input the memory channel name.
- ⑧ Push **[MEM]** to set the memory channel name.

• Selectable characters

0 1 2 3 4 5 6 7 8 9 ; < = > ? @
A B C D E F G H I J K L M N O P Q R S T U V W X Y Z [\] ^ _ `
a b c d e f g h i j k l m n o p q r s t u v w x y z { } ~ ■ ! " # \$ % & ' () * + , - . /

■ Programming group names (Group memory channel only)

The memory groups can display a six character name in addition to the group number (“GRP01”–“GRP20”).

- ① Push **[RCL]**, then rotate **[O-DIAL]** to select the desired memory channel in the memory mode.
 - Rotate **[O-DIAL]** to select the memory channel type if necessary.
- ② Push **[DIAL]**, and then rotate **[O-DIAL]** to select the memory group from GRP01 to GRP20, if necessary.
 - Push **[DIAL]** again to set the memory group.
- ③ Push **[MEM]**, then rotate **[O-DIAL]** to select “GRP NAME.”
- ④ Push **[MEM]**, and the group name’s 1st digit blinks.
- ⑤ Rotate **[DIAL]** to select the desired character.
 - The character type as shown left “Selectable characters” are selectable.
 - Push **[DIAL]** to switch from capital letters (A, B, C, ...) → lower case (a, b, c, ...) → number (0, 1, 2, ...) → then again to capital letters (A, B, C, ...) in sequential order.
- ⑥ Rotate **[O-DIAL]** to select the next input digit.
- ⑦ Repeat ⑤–⑥ to input the group name.
- ⑧ Push **[MEM]** to set the group name.

3 MEMORY OPERATION

■ Programming channel tag (Group memory channel only)

The tag name can be set a three character name in addition to the group number. It is convenient for separating memory type.

- ① Push **[RCL]**, then rotate **[O-DIAL]** to select the desired group memory channel in the memory mode.
 - Rotate **[O-DIAL]** to select the memory channel type if necessary.
- ② Push **[MEM]**, then rotate **[O-DIAL]** to select “CH TAG” when selecting “LABEL” in “Group memory channel display” of the menu mode (p. 22).
- ③ Push **[MEM]**, then rotate **[DIAL]** to select the desired channel tag.



- The tag type as shown below is selectable.
- ④ Push **[MEM]** to set the channel tag.

• Selectable tags

___ / TWR / GND / ATS / ATF / APP / ARR / AWS / CLR / CTF / DEP / FSS / RFS / UNI / MF / OTH / U-1 / U-2

■ Channel tag list

TAG NAME	DISPLAY		MEANS
	Group*1	GPS*2	
___	YES	—	Non-tag
TWR	YES	YES	Tower
GND	YES	YES	Ground
ATS	YES	YES	ATIS
ATF	YES	YES	Air traffic
APP	YES	YES	Approach
ARR	YES	YES	Arrival
AWS	YES	YES	Automatic Weather Station
CLR	YES	YES	Clearance / Delivery
CTF	YES	YES	Common Traffic Advisory Frequency
DEP	YES	YES	Departure Frequency
FSS	YES	YES	Flight Service Station
RFS	YES	YES	Remote Flight Service Station
UNI	YES	YES	Unicom frequency
MF	YES	YES	Mandatory frequency
OTH	YES	—	Other
U-1	YES	—	User1 setting (Refer to page 24)
U-2	YES	—	User2 setting (Refer to page 24)

*1Group memory, *2GPS memory

■ GPS memory

When connected to an external GPS receiver* equipped with an airport frequency database, frequency data such as nearby airports can be transferred and made available in the GPS memory (maximum 10-memory channels).

*Ask your dealer for available GPS receiver details.

NOTE:

- See the GPS receiver's instruction manual for transferring the frequency data.
- Ask your dealer for available GPS receiver details.

- ① Push **[RCL]** to enter the memory mode.
 - The channel number appears.
- ② Rotate **[O-DIAL]** to select the GPS memory channel.
 - "GPS" appears.
- ③ Rotate **[DIAL]** to select the desired channel.
- ④ Push **[RCL]** to exit the GPS memory mode.

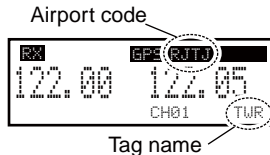

■ GPS memory edit

The received GPS memory data is stored in the desired group memory channel.

NOTE: The GPS memory data is overwritten if the selected GPS memory channel already contains other data.

- ① Push **[RCL]** to enter the memory mode.
 - The channel number appears.
 - The memory channel name also appears if it has been entered.
- ② Rotate **[O-DIAL]** to select the GPS memory channel.
 - "GPS" appears.
- ③ Push **[MEM]** to enter the GPS memory channel edit mode, then rotate **[O-DIAL]** to select the desired group memory.
 - "GPS" and airport code blink.
- ④ Push **[MEM]** to store the GPS memory channel data to the selected group memory.
- ⑤ Push **[RCL]** to exit the memory mode.

■ Memory protection

The transceiver has memory protection which inhibits to the editing (storing, deleting, replacing, etc.) of the memory group memory channels.

Refer to "Memory Protection" (p. 22) for details.

■ Lock function

The lock function prevents accidental frequency changes and accidental function activation.

- ① Hold down **[DIAL]** for 2 seconds to turn the lock function ON.
 - “**LCK**” appears when DIAL lock mode is selected.
 - “**LCK**” appears when PANEL lock mode is selected.
- ② To turn the function OFF, repeat step ① above.
 - “**LCK**” or “**LCK**” disappears.

NOTE: AUTOMATIC LOCK RELEASE FUNCTION

This transceiver has an “Automatic Lock Release Function” which releases the Lock function automatically when an operator gets into a panic.

The lock function is released when pushing any keys (except **[EC]**) eight times or rotating any dials (except **[VOL]**) 25-clicks for 5 seconds.

■ Accessing 121.5 MHz emergency frequency

The IC-A210E can be set to the 121.5 MHz emergency frequency quickly. This function can be activated even when the key lock function is in use.

- ① Push **[EC]** to call the emergency frequency to the standby frequency, and enter the DualWatch operation automatically.
- ② Push **[↔]** to transfer emergency frequency to the active frequency if necessary.
 - “**EC**” appears.
- ③ Push **[↔]** to exit from the emergency frequency.
 - Set the frequency except 121.500 MHz before pushing **[↔]** to the standby frequency if necessary.
 - “**EC**” disappears.

NOTE: “**EC**” also appears on the display while the active frequency is set to 121.500 MHz.

CONVENIENT!: Hold down **[EC]** for 2 seconds to enter the direct frequency setting mode (p. 8), and set the emergency frequency (121.5 MHz).

- “**EC**” appears.

■ Intercom function

When two headphone and microphone jacks are connected to the transceiver, these headsets can be used as a voice-activated intercom.

- ① Enter to the MENU mode.
 - See page 20 for details.
- ② Set Intercom Usable Setting to ON.
 - See page 25 for details.
- ③ Exit from the MENU mode.
 - See page 20 for details.
- ④ Hold down **[DUAL]** for 2 seconds to enable the intercom function.
 - “ICS” appears.

- The headphone audio output level can be selected “OFF,” “output level fixing (001 to 080)” or “interlocking with [VOL]” in the MENU mode (p. 21).
- The microphone1 and microphone2 audio input levels can be also selected “OFF” or “output level fixing (001 to 080)” in the MENU mode (p. 21).

■ Squelch test function

This function opens the squelch manually for testing.

- ① Push **[VOL]** to turn the squelch test function ON.
 - “TEST” appears.
- ② To turn the function OFF, repeat step ① as above.
 - “TEST” disappears.

■ Frequency step setting

Frequency step (8.33 kHz or 25 kHz) is selectable in the menu mode.

- ① Enter the menu mode (See page 20 for details).
- ② Rotate **[O-DIAL]** to select the “FREQ. STEP (Frequency step).”
- ③ Rotate **[DIAL]** to select the desired frequency step (8.33 kHz or 25 kHz).
- ④ Push **[RCL]** to exit MENU mode, and returning to the previous operating condition.

■ MENU mode programming

MENU mode is available at power ON and allows you to set seldom-changed settings. In this way you can customize transceiver operations to suit your preferences and operating style.

◇ Operating MENU mode

- ① Rotate [VOL] to turn the transceiver's power ON.
- ② Push [RCL] to set VFO mode if memory mode is selected.
- ③ Hold down [RCL] for 2 seconds to enter the MENU mode.
- ④ Rotate [O-DIAL] to select setting items.
- ⑤ Rotate [DIAL] to select the desired setting.
- ⑥ Push [RCL] to exit MENU mode, and returning to the previous operating mode.

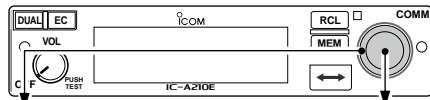

Menu mode items setting

Desired condition setting

```
SQL LEVEL
HP LEVEL
INCOM LV1
INCOM LV2
⋮
```

```
-010
-009
⋮
009
010
```

• MENU mode items

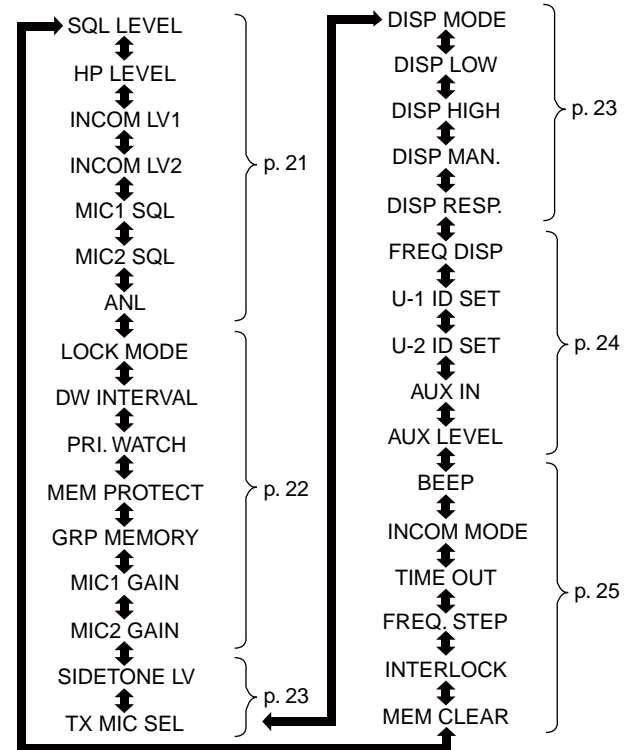

■ MENU mode items

◇ AM Squelch Level “SQL LEVEL”

Set the squelch level for AM mode operation.

In order to receive signals properly, the squelch must be adjusted to the proper level.

- -010 to 010 : Setting AM squelch level from -10 to +10.

◇ Headphone Level “HP LEVEL”

Set the headphone output level while receiving.

- AF gain : The output level is same as [VOL].
- OFF (0) : Mutes the headphone.
- 001 to 080 : Sets audio level from 1 to 80.

◇ Intercom1 Microphone Audio Input Level “INCOM LV1”

Set the intercom1 microphone input level.

- OFF (0) : Mutes the intercom1 microphone.
- 001 to 080 : Sets the intercom1 input level from 1 to 80.

◇ Intercom2 Microphone Audio Input Level “INCOM LV2”

Set the intercom2 microphone input level.

- OFF (0) : Mutes the intercom2 microphone.
- 001 to 080 : Sets the intercom2 input level from 1 to 80.

◇ Intercom1 Squelch Level “MIC1 SQL”

Set the intercom1 squelch level.

The setting level is required to open the squelch when speaking to the intercom1.

- OFF (0) : Turns off the intercom1 squelch.
- 001 to 030 : Sets the intercom1 squelch level from 1 to 30.

◇ Intercom2 Squelch Level “MIC2 SQL”

Set the intercom2 squelch level.

The setting level is required to open the squelch when speaking to the intercom2.

- OFF (0) : Turns off the intercom2 squelch.
- 001 to 030 : Sets the intercom2 squelch level from 1 to 30.

◇ Automatic Noise Limiter “ANL”

The ANL (Automatic Noise Limiter) function reduces noise components such as that caused by engine ignition systems while receiving.

- OFF : ANL function OFF.
- ON : ANL function ON.

5 MENU MODE

■ MENU mode items (Continued)

◇ Lock Mode “LOCK MODE”

Set the lock function.

- OFF : The lock function is OFF.
- DIAL : The lock function applies to [DIAL].
- PANEL : The lock function applies to buttons on the front panel.

◇ DualWatch Interval “DW INTERVAL”

Set the interval time while operating DualWatch.

- FAST : Sets the interval time to 300 milliseconds.
- MID : Sets the interval time to 600 milliseconds.
- SLOW : Sets the interval time to 2 seconds.

◇ Priority Watch Interval “PRI. WATCH”

Set the active frequency receive interval time while receiving the standby frequency.

- FAST : Sets the interval time to 400 milliseconds.
- MID : Sets the interval time to 800 milliseconds.
- SLOW : Sets the interval time to 2 seconds.

NOTE: The priority watch interval does not appear when the “PRIORITY WATCH” is set to “OFF,” by the CS-A210.

◇ Memory Protection “MEM PROTECT”

Set the memory protection to regular memory channels and group memory channels.

Editing the regular memory and group memory channels is inhibited while the protection is ON.

- OFF : The memory protection is OFF.
- ON : The memory protection is ON.

◇ Group Memory Channel Display “GRP MEMORY”

Set the displaying whether the label displays or not.

- CH : Only the channel number is displayed.
- LABEL : The label is also displayed.

◇ Microphone1 Gain “MIC1 GAIN”

Set the microphone1's gain.

- -010 to 010 : Setting the microphone1's gain from -10 to +10.

◇ Microphone2 Gain “MIC2 GAIN”

Set the microphone2's gain.

- -010 to 010 : Setting the microphone2's gain from -10 to +10.

◇ Sidetone Level “SIDETONE LV”

When using an optional headset (supplied from third party*) via the adapter, the transceiver outputs your transmitted voice to the headset for monitoring.

*Ask your dealer in details.

- OFF (0) : The sidetone function is OFF.
- 001 to 080 : Sets the sidetone level from 1 to 80.

◇ Transmitting Microphone Selection “TX MIC SEL”

Set the active microphone when pushing microphone’s PTT switch.

The item allows you to control which connected microphone is permitted to transmit.

- MIC1 : Selects microphone1.
- MIC2 : Selects microphone2.
- MIC1+2 : Selects both microphone1 and microphone2.

◇ Dimmer Mode “DISP MODE”

The light sensor which is built into the display is used for this function.

Set the OLED dimmer mode.

- OFF : The dimmer function is OFF.
- AUTO : Sets the dimmer automatically depending on local brightness.
- MANUAL : Sets the dimmer depending on Dimmer Brightness (Low) “DISP LOW.”

◇ Dimmer Brightness (Low) “DISP LOW”

Set the lower brightness level in the automatic adjustment range when “AUTO” is selected at the “Dimmer Mode.”

The transceiver automatically adjusts its display brightness by the current lighting conditions.

- OFF : The key backlight sets OFF.
- 001 to 049 : Sets the low dimmer brightness level from 1 to 49.

◇ Dimmer Brightness (High) “DISP HIGH”

Set the upper brightness level in the automatic adjustment range when “AUTO” is selected in the Dimmer Mode.

- 050 to 100 : Sets the dimmer brightness level from 50 to 100.

◇ Dimmer Brightness (Manually) “DISP MAN.”

Set the brightness manually to suit your own preferences.

- 000 to 100 : Sets the dimmer level manually from 0 (OFF) to 100.

◇ Dimmer Response “DISP RESP.”

Set the dimmer switching speed when selecting “AUTO” at the “Dimmer Mode.”

- STANDARD : Selects normal switching speed.
- FAST : Selects fast switching speed.

5 MENU MODE

■ MENU mode items (Continued)

◇ Frequency Display “FREQ DISP”

Set the 1 kHz digit frequency displaying in the OLED.

- OFF : The 1 kHz digit is not displayed in the OLED.
- ON : The 1 kHz digit is always displayed in the OLED.
- ZERO SUPP. : The 1 kHz is digit display on the OLED as 0.

◇ USER-1 Setting “U-1 ID SET”

Set the USER-1, channel tag, to the desired ID.

- ① Push **[MEM]** to enter the U-1 ID edit mode.
- ② Rotate **[DIAL]** to select the desired character.
- ③ Rotate **[O-DIAL]** to select the next input digit.
- ④ Repeat ②–③ to input the U-1 ID.
- ⑤ Push **[MEM]** again to store the U-1 ID, and exit the edit mode.

◇ USER-2 Setting “U-2 ID SET”

Set the USER-2, channel tag, to the desired ID.

- ① Push **[MEM]** to enter the U-2 ID edit mode.
- ② Rotate **[DIAL]** to select the desired character.
- ③ Rotate **[O-DIAL]** to select the next input digit.
- ④ Repeat ②–③ to input the U-2 ID.
- ⑤ Push **[MEM]** again to store the U-2 ID, and exit the edit mode.

◇ External Input “AUX IN”

Set the external input mode.

- OFF : The external input is OFF.
- ON : The external input is available while the squelch is closed.
- INCOM : The external input is available with the intercom operations as following.
 - The intercom function is OFF.
 - While the intercom function is not in use.
 - While an audio signal is not input into the intercom’s microphone.

◇ External Input Level “AUX LEVEL”

Set the external input level.

- OFF (0) : The external input does not operate.
- 001 to 080 : Sets the external input level from 1 to 80.
- AF GAIN : Interlocked with [VOL].

◇ Beep Tone Level “BEEP”

Confirmation beep tones normally sound when storing memory, operating time-out-timer function, etc. These can be set the desired beep level as you prefer.

- OFF (0) : The beep tone turns OFF.
- 001 to 100 : Setting the beep tone level from 1 to 100.

NOTE: When using an external speaker, the beep tone level when the squelch is closed is fixed and cannot be changed in the MENU mode.

◇ Intercom Usable Setting “INCOM MODE”

Set the intercom using or not.

- ON : The intercom is usable.
- OFF : The intercom is unusable.

◇ Time-Out-Timer “TIME OUT”

To prevent accidental prolonged transmission, the transceiver has a time-out-timer function. This timer starts when a transmission begins, and will cut off the transmission when the time set in the timer elapses.

- 020 to 240 : Setting time-out-timer starting period from 20 seconds to 240 seconds in 10 seconds intervals.

◇ Frequency Step “FREQ. STEP”

Set the desired frequency step: 8.33 kHz or 25 kHz.

- 25kHz : Setting the frequency step to 25 kHz.
- 8.33kHz : Setting the frequency step to 8.33 kHz.

◇ Interlock “INTERLOCK”

When two transceivers are connected together, the interlock function can prevent them from transmitting at the same time.

NOTE: The interlock does not appear when the “TX/RX INTERLOCK SW” is set to “DISABLE,” by the CS-A210.

- TX INHIBIT : Transmission is prevented.
- RX MUTE : Audio output is prevented.
- BOTH : Transmission and audio output are both prevented.

◇ Memory Clear “MEM CLEAR”

Set values in the CPU are cleared.

Hold down **[MEM]** for 2 seconds, the CPU is reset as follows.

- MENU : MENU mode items are reset.
- MEMORY : Stored memories are reset.
- ALL : All CPU data is reset.

◇ Data cloning

Cloning allows you to quickly and easily transfer the programmed contents or data from a PC to a transceiver using the optional CS-A210 CLONING SOFTWARE.

Data can be cloned to and from a PC (IBM compatible) using the optional CS-A210 CLONING SOFTWARE and the optional OPC-1529R CLONING CABLE (connect with the data jack). Consult the CS-A210 instruction manual and HELP file for details.

◇ Displayed Message

- While clone writing.

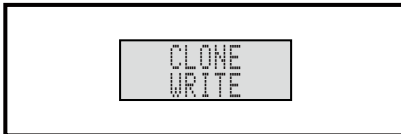

- When clone writing is finished properly.

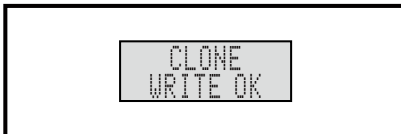

- When clone writing error occurs.

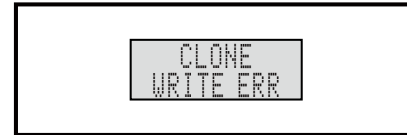

- While clone reading.

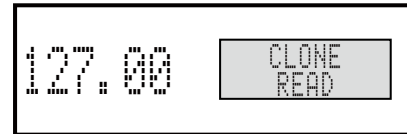

- If an error occurs while cloning, the following message appears when the power is turned OFF and then ON. In this case, re-cloning or re-writing the data correctly is necessary to cancel the error.

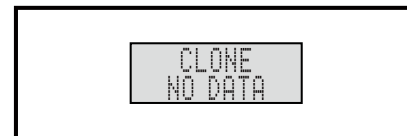

◇ **CS-A210** CLONING SOFTWARE

Provides quick and easy programming of items, including private channels, scan setting etc., via a PC to the transceiver.

◇ **OPC-1529R** CLONING CABLE

This cloning cable provides convenient connection to a PC to access programmable features, such as memory channels, memory name, etc.

◇ **MB-53** MOUNTING BRACKET

For mounting the transceiver. The external speaker and microphone are included.

◇ **MB-113** REAR PANEL ADAPTER

For the third party compatible type with rear panel adapter. Ask your dealer for compatible panel mount radio details.

NOTE: Supplied with some transceiver's versions.

◇ **General**

- Frequency range :
 - Tuning step 25 kHz : 118.000 to 136.975 MHz
 - Tuning step 8.33 kHz : 118.000 to 136.992 MHz
- Channel spacing : 25 kHz or 8.33 kHz
- Frequency stability : ± 1 ppm (0°C to +40°C)
- Operating temperature : -20°C to +55°C
- Antenna impedance : 50 Ω
- Number of memory channels : 10 memory channels
200 group channels
10 history channels
10 GPS channels
- Mode : AM (6K80A3E/5K00A3E)
- Power supply requirement : 13.80 V / 27.50 V DC
(negative ground)
- Dimensions : 160 (W)×34 (H)×271 (D) mm
(projections not incl.)
- Weight (approximately) : 1.0 kg

◇ **Transmitter**

- Mode : AM
- Output power : 6 W (Carrier power)
- Spurious emissions : -36 dBm (harmonics)
-46 dBm (non-harmonics)
- Microphone impedance : 600 Ω
- Modulation limiting : 85% (Max 95%)
- Transmitter intermittent : 1 minute (Transmitter ON)
duty cycle : 3 minutes (Transmitter OFF)

◇ **Receiver**

- Receive system : Double conversion
superheterodyne
- Intermediate frequencies : 1st 38.85 MHz
2nd 450 kHz
- Sensitivity : Less than -101 dBm
at 12 dB SINAD
- Selectivity :
 - Tuning step 25 kHz : 6 dB ± 8.5 kHz
 - Tuning step 8.33 kHz : 6 dB ± 2.8 kHz
- Spurious response rejct. : More than 70 dB
- Audio output power : 5 W with a 4 Ω load (External
speaker)
60 mW with a 500 Ω load
(Headphone)

All stated specifications are subject to change without notice or obligation.

■ Channel ID list

- Channel spacing: 25 kHz (Actual frequency is displayed.)

Operating Frequency (MHz)	Channel spacing (kHz)	Channel ID (Displayed Frequency)
118.0000	25	118.000
118.0250	25	118.025
118.0500	25	118.050
118.0750	25	118.075
118.1000	25	118.100

- Channel spacing: 8.33 kHz

Operating Frequency (MHz)	Channel spacing (kHz)	Channel ID (Displayed Frequency)
118.0000	8.33	118.005
118.0083	8.33	118.010
118.0167	8.33	118.015
118.0250	8.33	118.030
118.0333	8.33	118.035
118.0417	8.33	118.040
118.0500	8.33	118.055
118.0583	8.33	118.060
118.0667	8.33	118.065
118.0750	8.33	118.080
118.0833	8.33	118.085
118.0917	8.33	118.090
118.1000	8.33	118.105

These tables show just the display example between 118.0000 MHz and 118.1000 MHz, not show all frequencies in the band.

■ About CE and DOC

CE Hereby, Icom Inc. declares that the versions of IC-A210E which have the “CE” symbol on the product, comply with the essential requirements of the Radio Equipment Directive, 2014/53/ EU, and the restriction of the use of certain hazardous substances in electrical and electronic equipment Directive, 2011/65/EU. The full text of the EU declaration of conformity is available at the following internet address:

<http://www.icom.co.jp/world/support/>

■ Disposal



The crossed-out wheeled-bin symbol on your product, literature, or packaging reminds you that in the European Union, all electrical and electronic products, batteries, and accumulators (rechargeable batteries) must be taken to designated collection locations at the end of their working life. Do not dispose of these products as unsorted municipal waste. Dispose of them according to the laws in your area.

INDEX

A	
Accessing 121.5 MHz emergency frequency	18
AM squelch level	21
Automatic noise limiter	21

B	
Basic operation	5
Beep tone level	25
Blank channel	9

C	
Channel selection	10
Channel tag list	16
Clearing the memory contents	14
Cloning	26
COUNTRY CODE LIST	30

D	
Data cloning	26
Dimmer brightness (High)	23
Dimmer brightness (Low)	23
Dimmer brightness (Manually)	23
Dimmer mode	23
Dimmer response	23
Direct frequency selection	5
Direct frequency setting mode operation	8
Displayed message	26
DualWatch interval	22
DualWatch operation	8

E	
Emergency frequency	18
Entering memory mode	9
External input	24
External input level	24

F	
Frequency display	24
Frequency exchanging	6
Frequency selection	5
Frequency setting example	7
Frequency step	25
Frequency step setting	19
Front panel	1
Function display	4

G	
General frequency selection	5
GPS memory	17
GPS memory channel	9
GPS memory edit	17
Group memory channel	9, 13
Group memory channel display	22

H	
Headphone level	21
History memory channel	9, 14

I	
Intercom function	19
Intercom usable setting	25
Intercom1 Microphone audio input level	21
Intercom1 squelch level	21
Intercom2 Microphone audio input level	21
Intercom2 squelch level	21
Interlock	25

L	
Lock function	18
Lock mode	22

M

Memory channel type 9

Memory clear..... 25

Memory mode menu 12

Memory operation 9

Memory protect function..... 9

Memory protection..... 17, 22

Menu mode items 21

Menu mode programming 20

Microphone1 gain 22

Microphone2 gain 22

O

Operating menu mode..... 20

Other functions 18

P

Panel descriptions 1

Priority watch interval 22

Programming channel names..... 15

Programming channel tag 16

Programming example..... 11

Programming group names 15

Programming notes 9

Programming a memory channel 10

R

Regular memory channel 9, 13

S

Sidetone level 23

Squelch test function 19

Standby frequency selection 5

T

Time-Out-Timer 25

Transferring memory contents 12

Transmitting 6

Transmitting microphone selection 23

U

USER-1 setting..... 24

USER-2 setting..... 24

Count on us!

A6606H-1EU-8
Printed in Japan
© 2008–2018 Icom Inc.

Printed on recycled paper with soy ink.

Icom Inc.

1-1-32 Kamiminami, Hirano-ku, Osaka 547-0003, Japan